

CUBO

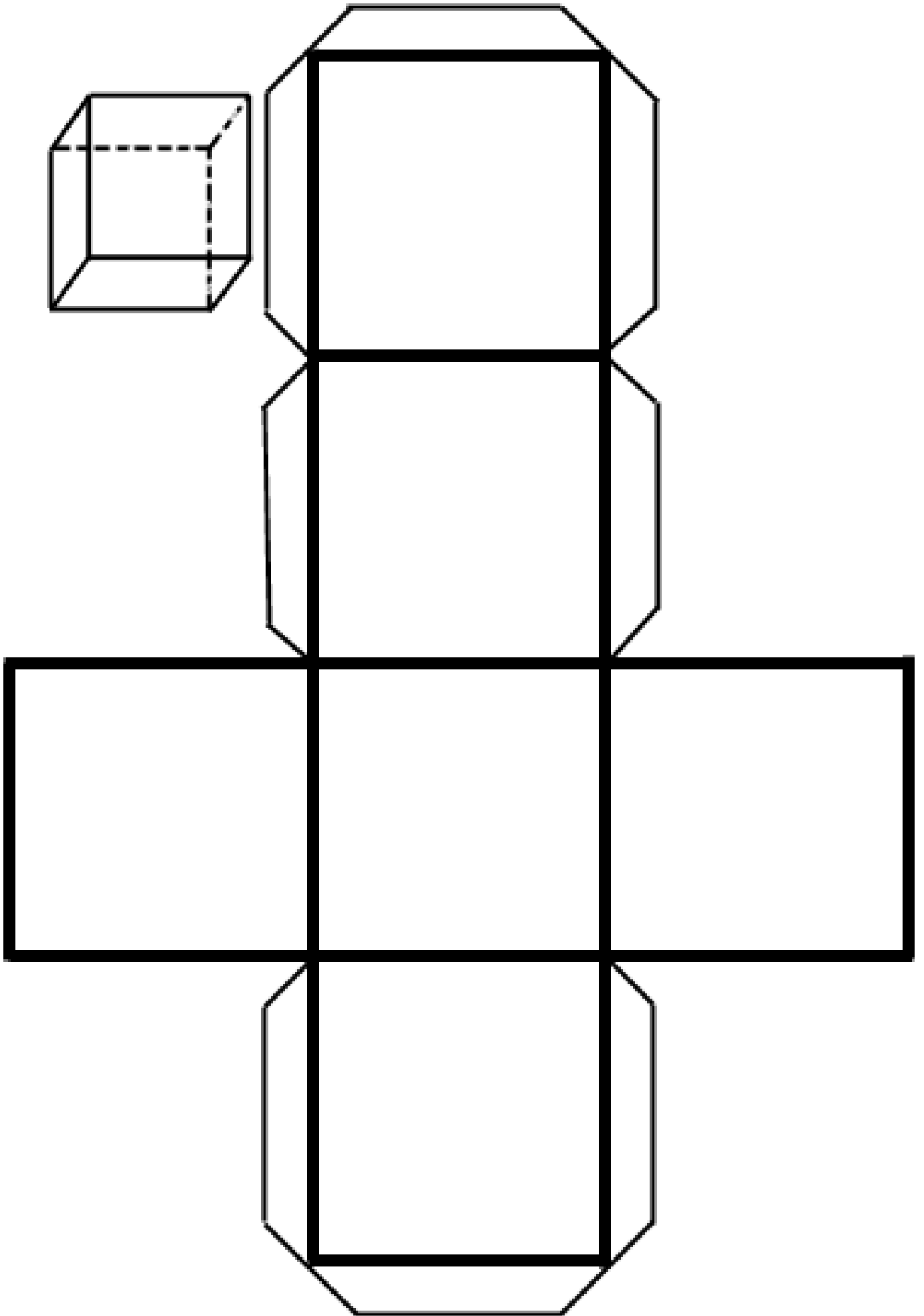

# TETRAEDRO

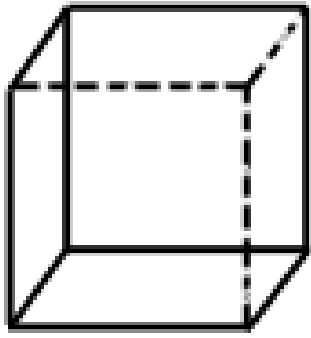
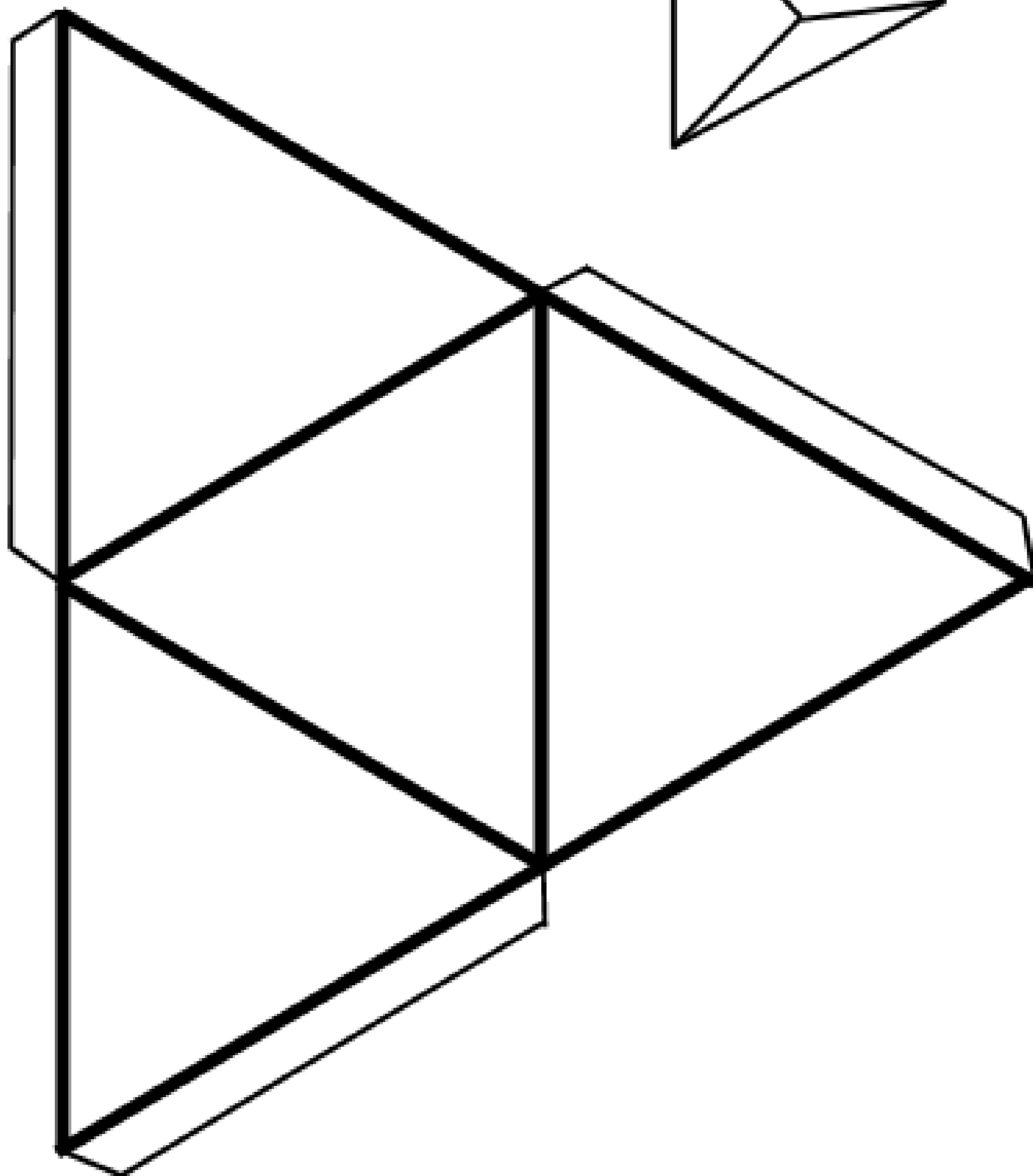
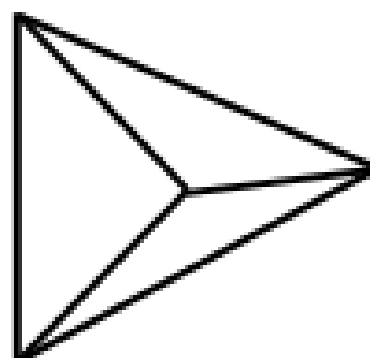

# DODECAEDRO

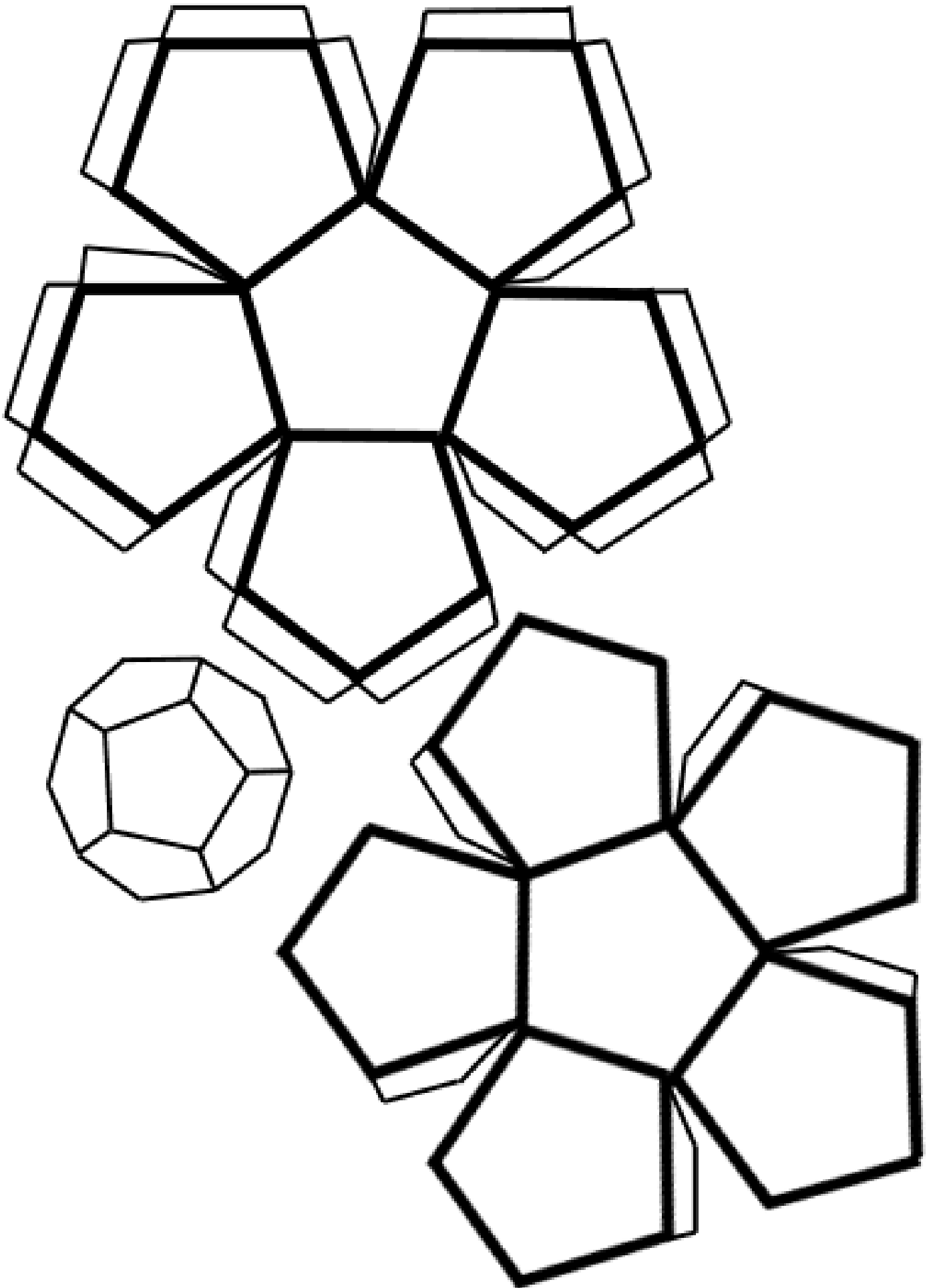

OCTAEDRO

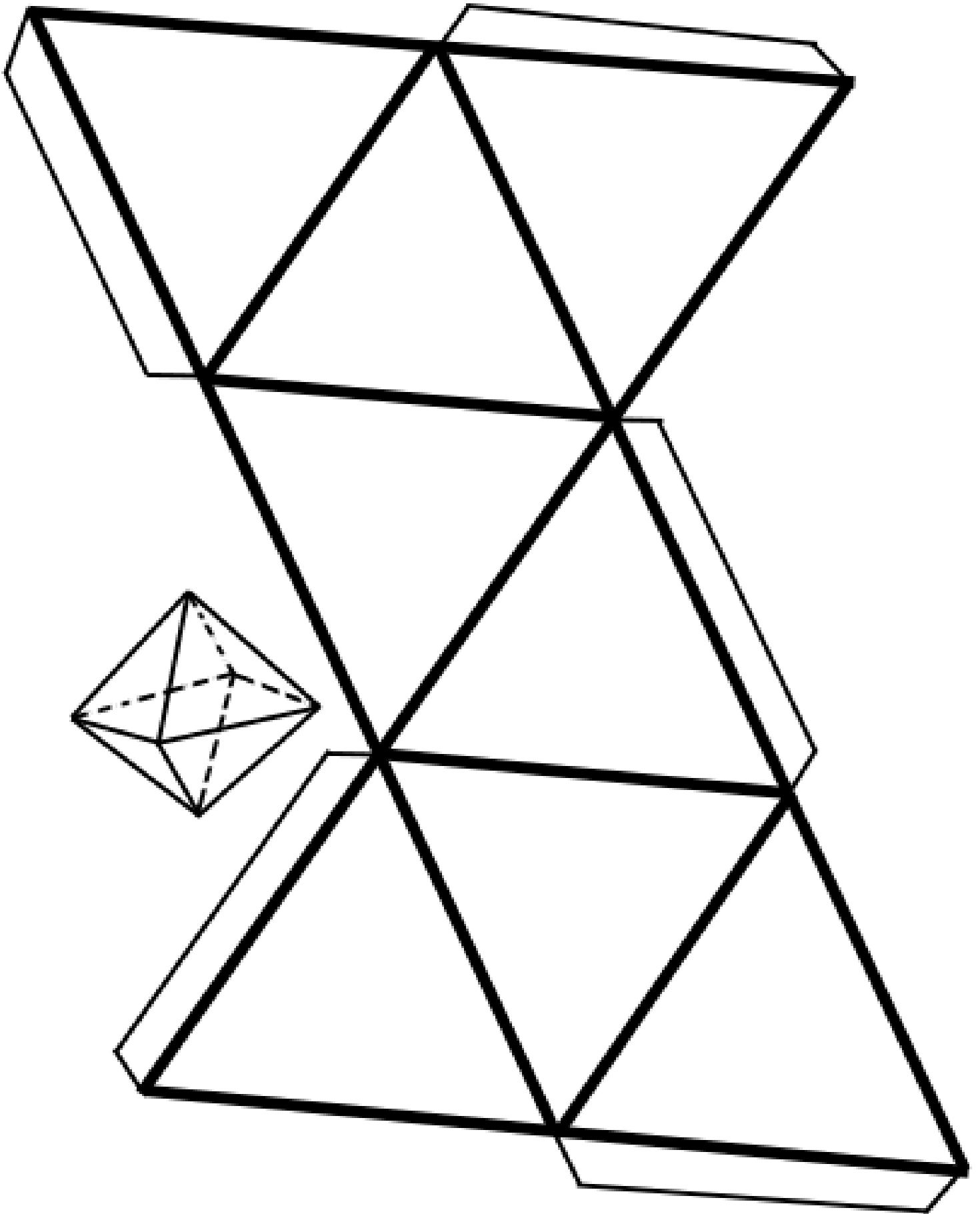

# PIRÁMIDE TRIANGULAR

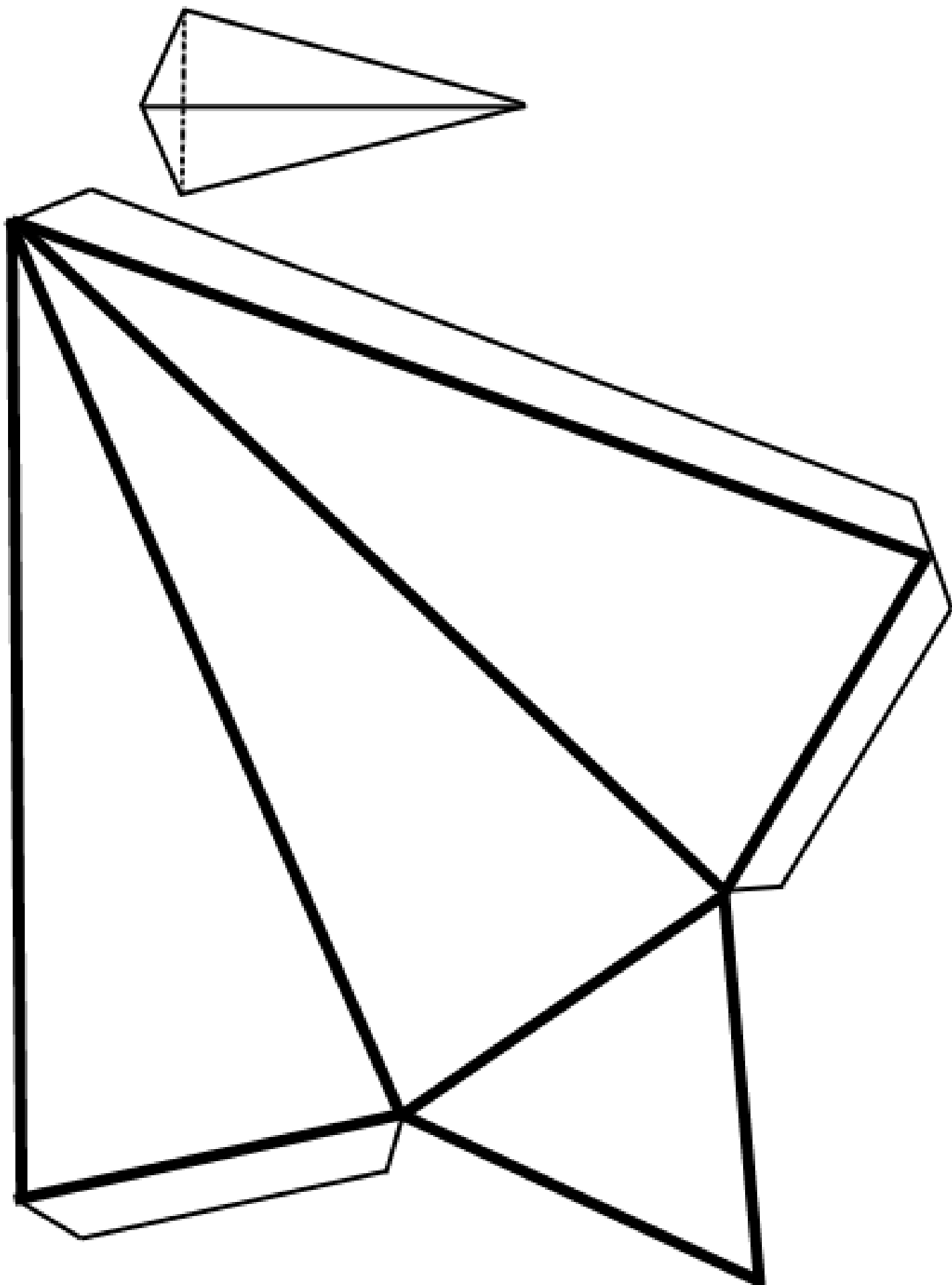



# PIRÁMIDECUADRANGULAR

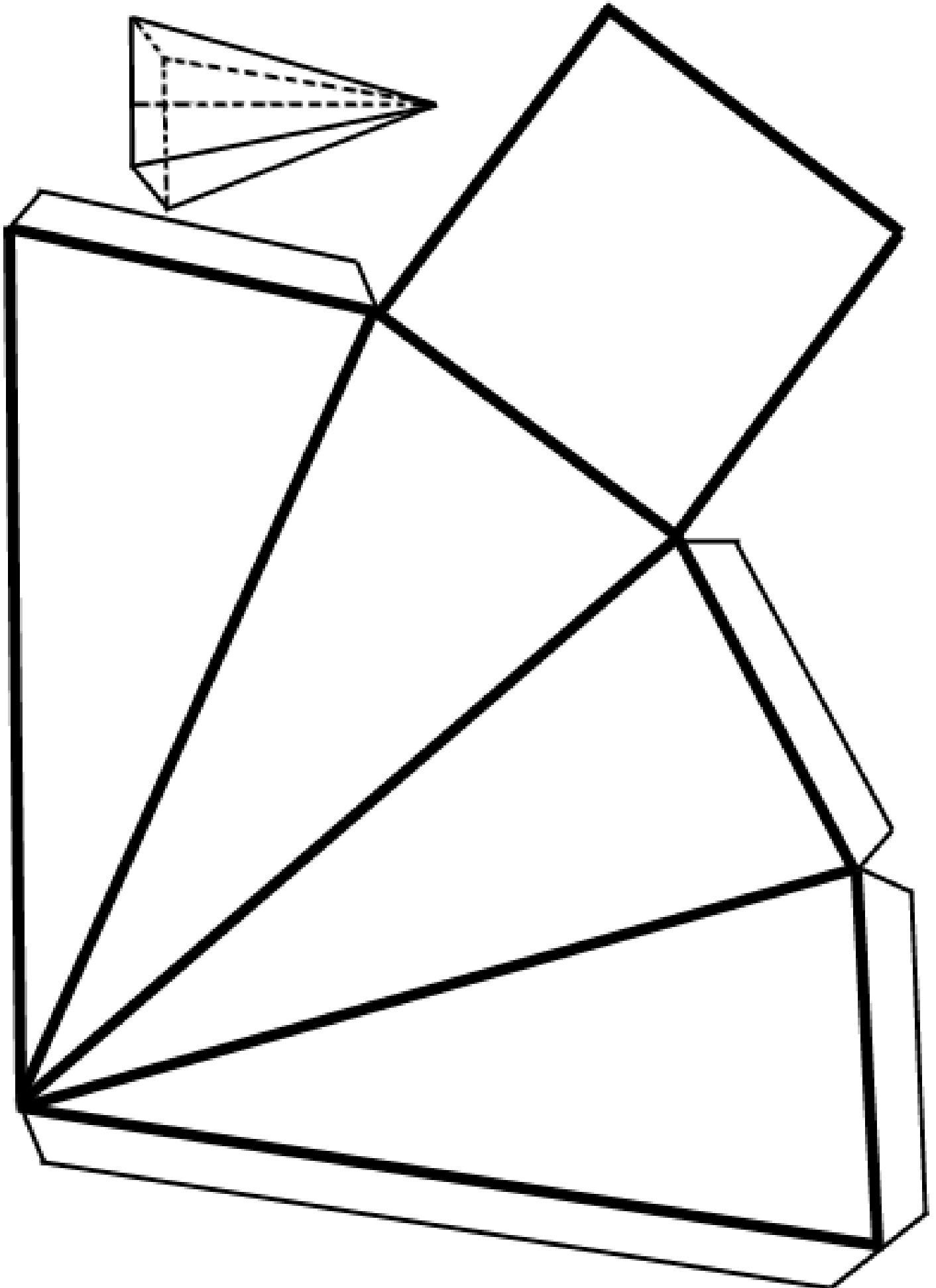

# PIRÁMIDE PENTAGONAL

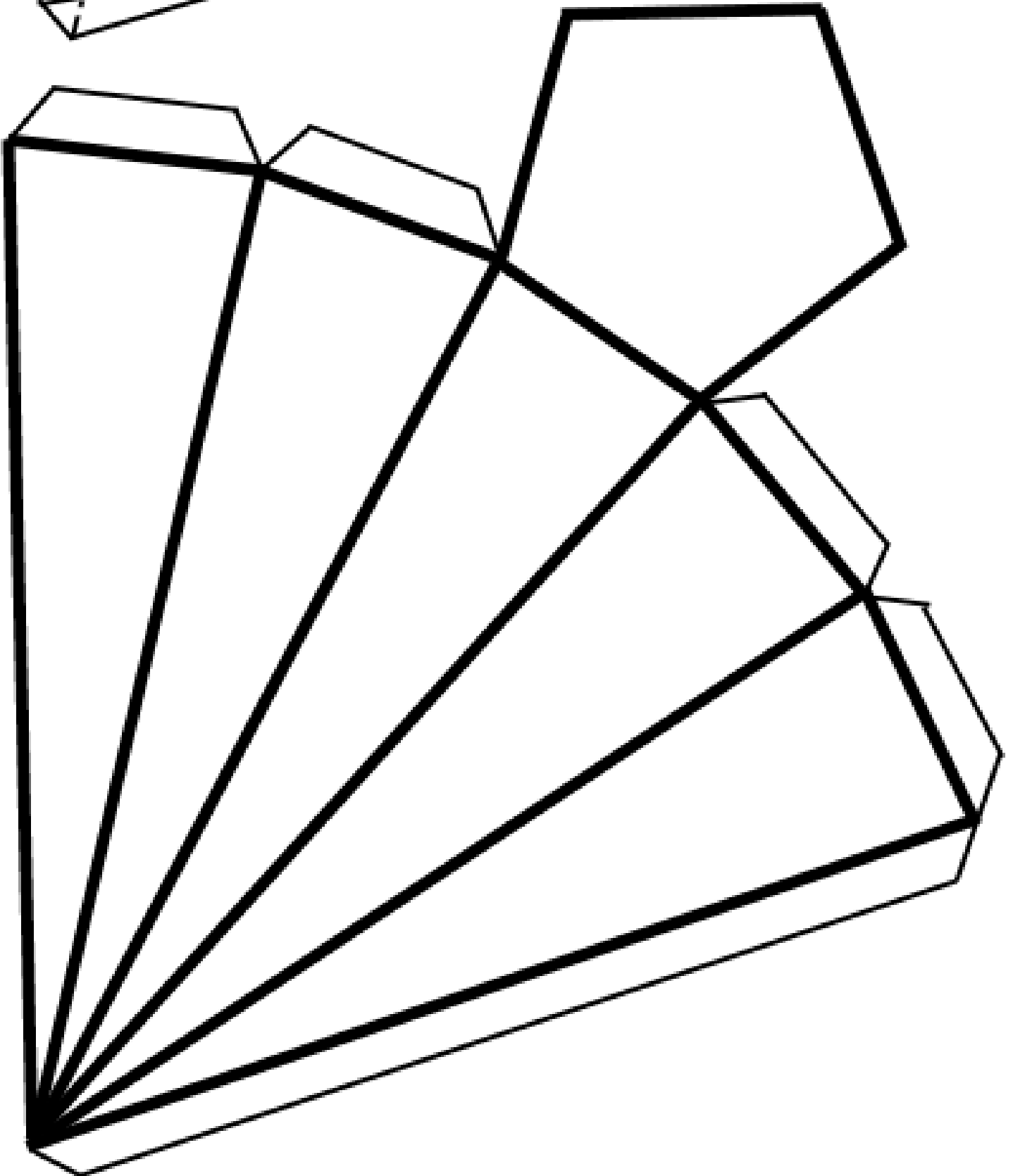
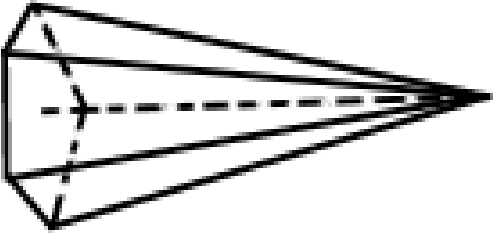

# PIRÁMIDE HEXAGONAL

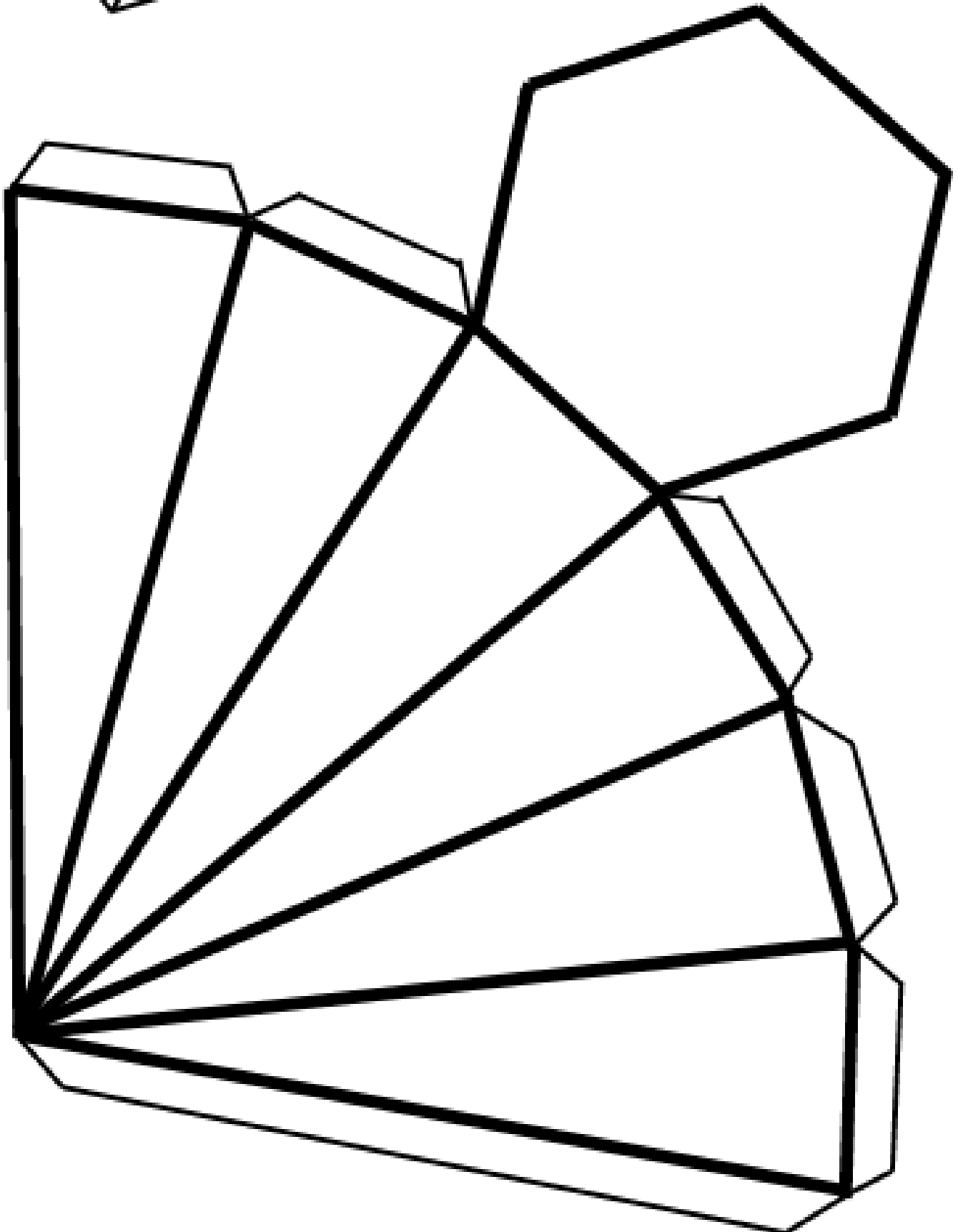
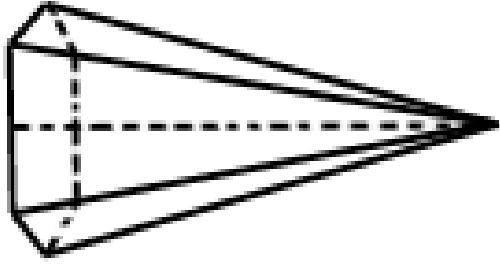

# PIRÁMIDE OCTOGONAL

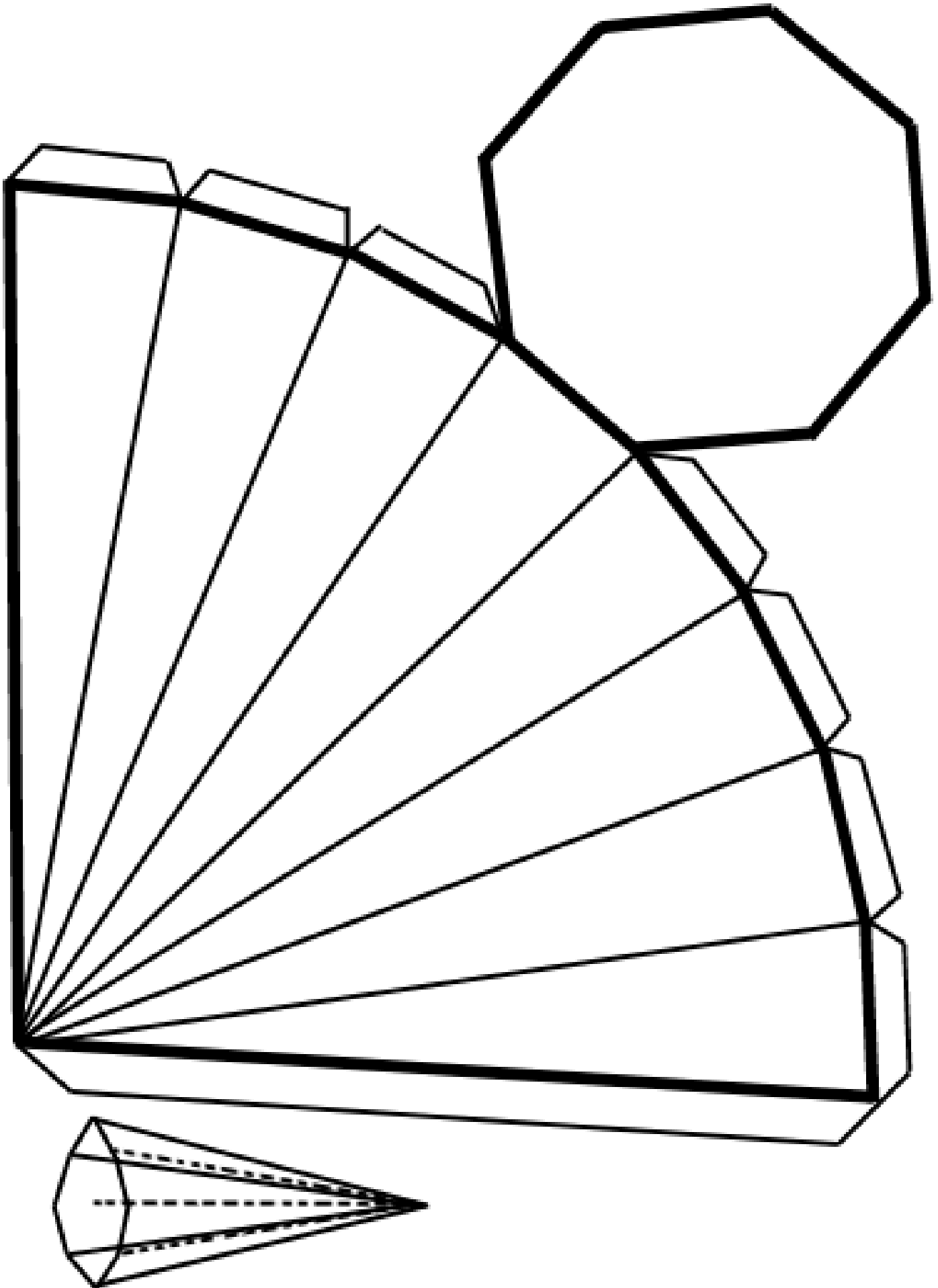

# PRISMATRIANGULAR

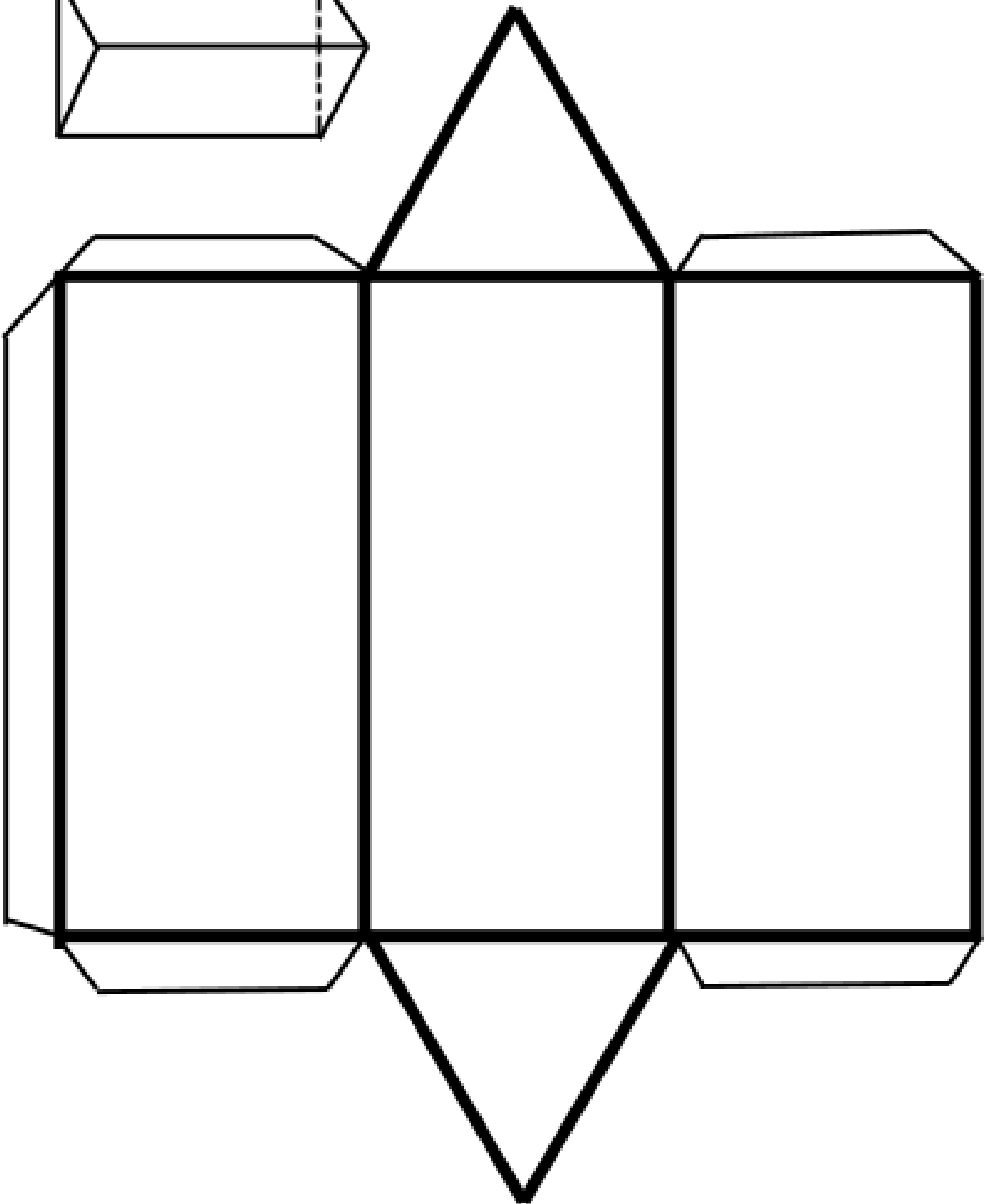
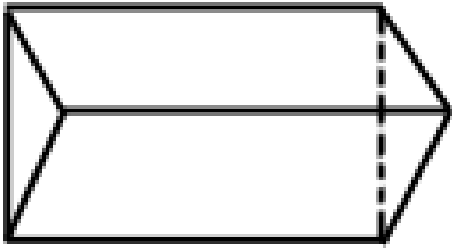

# PRISMACUADRANGULAR

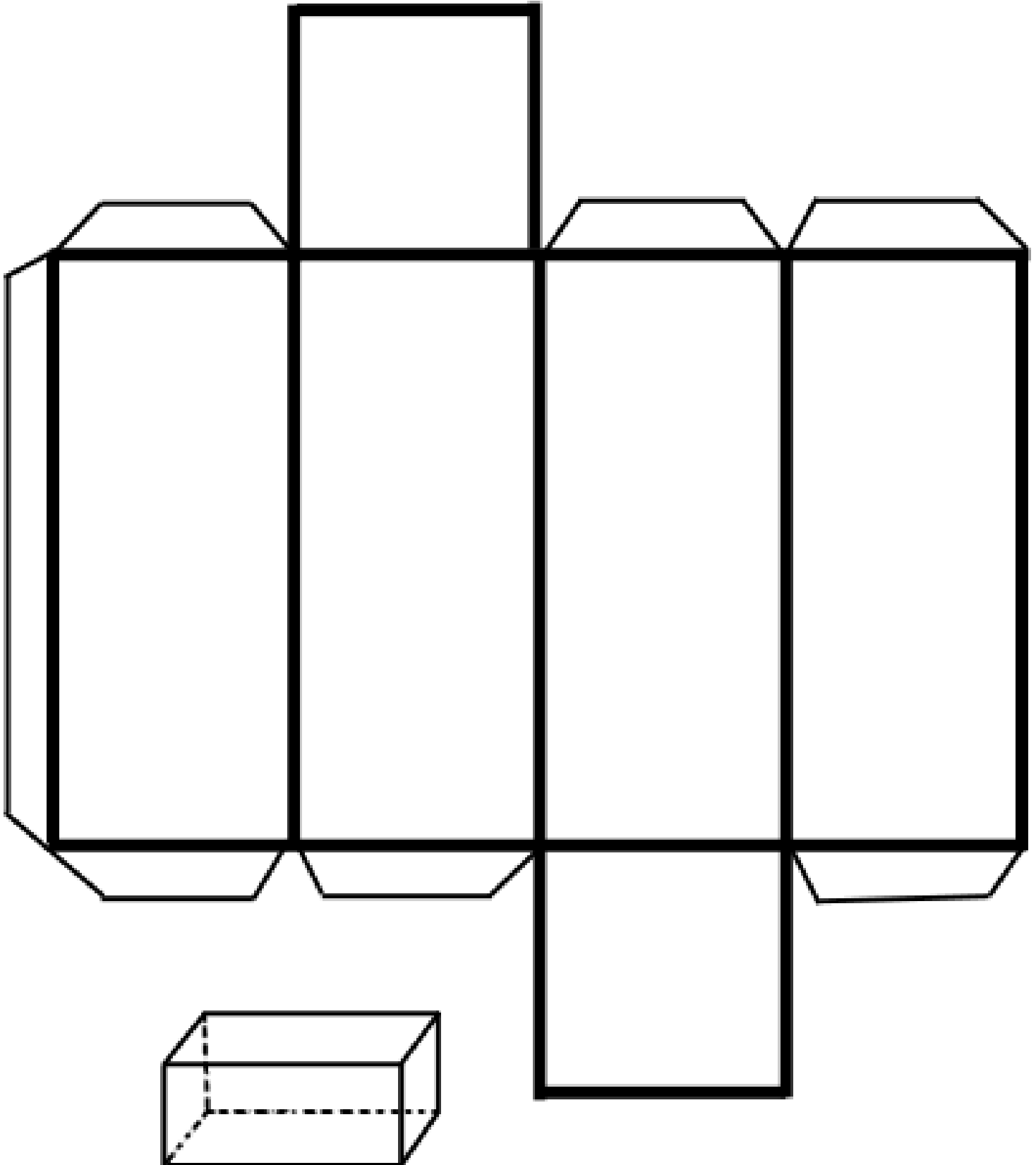

PRISMAPENTAGONAL

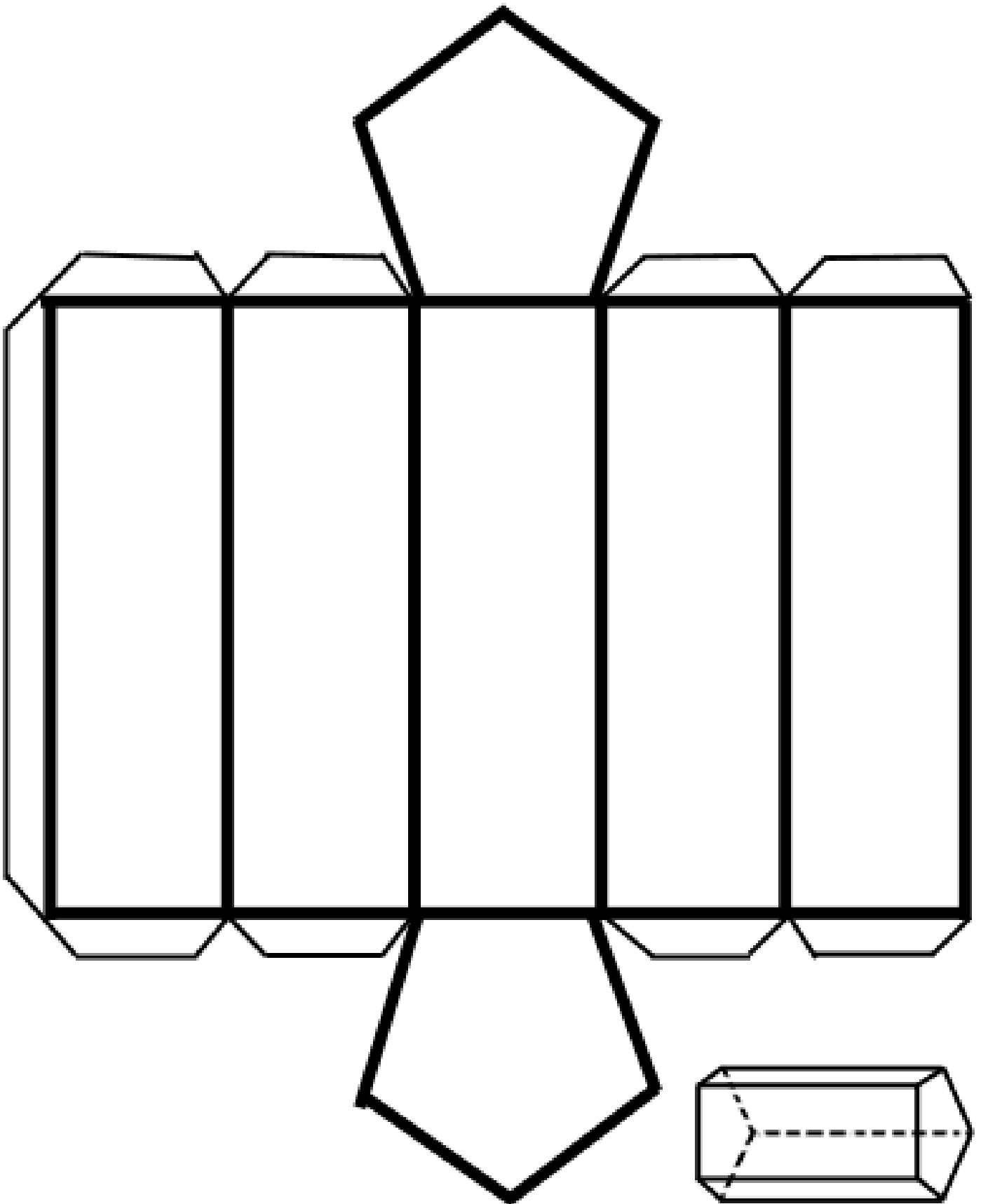

PRISMAHEXAGONAL

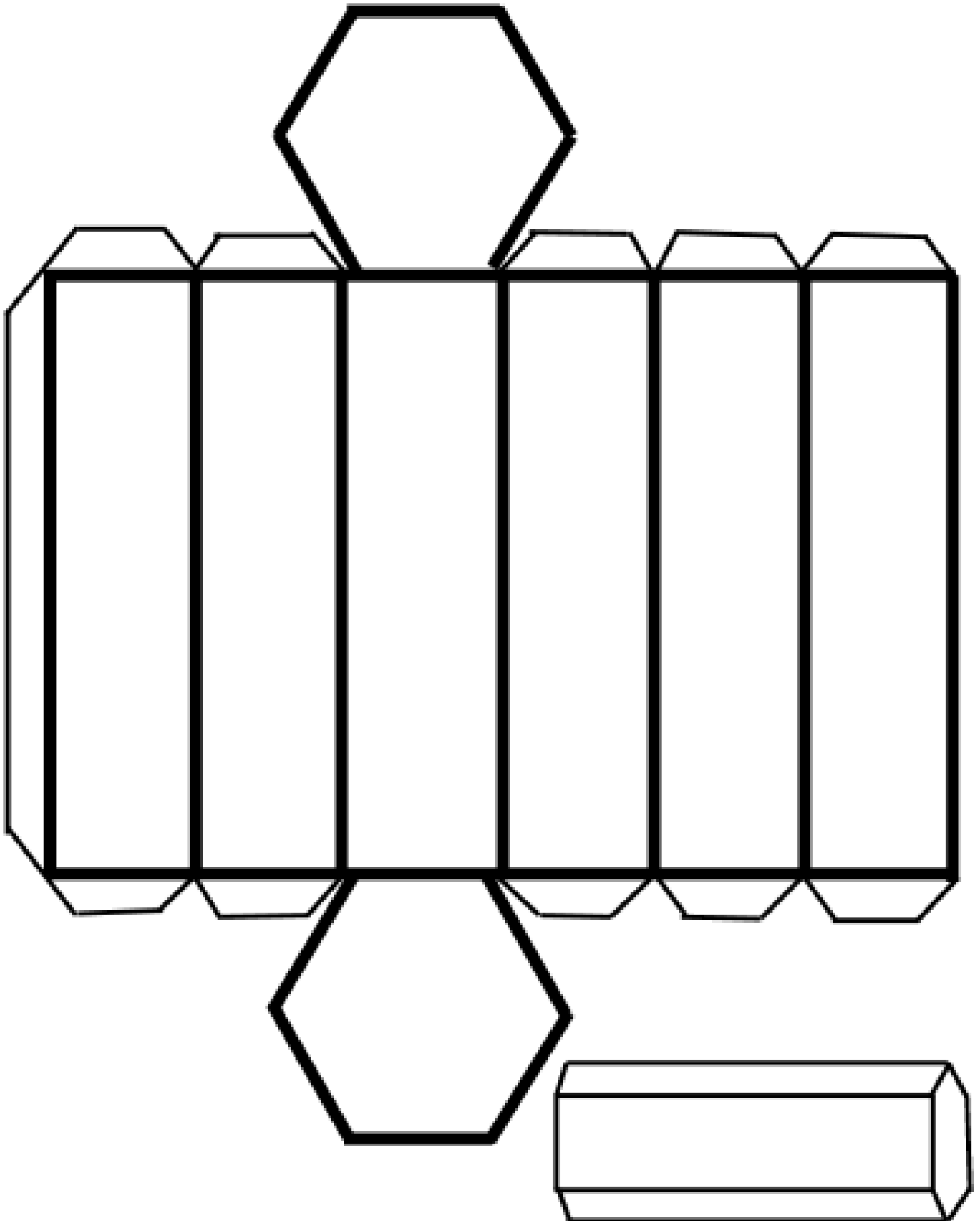

CILINDRO

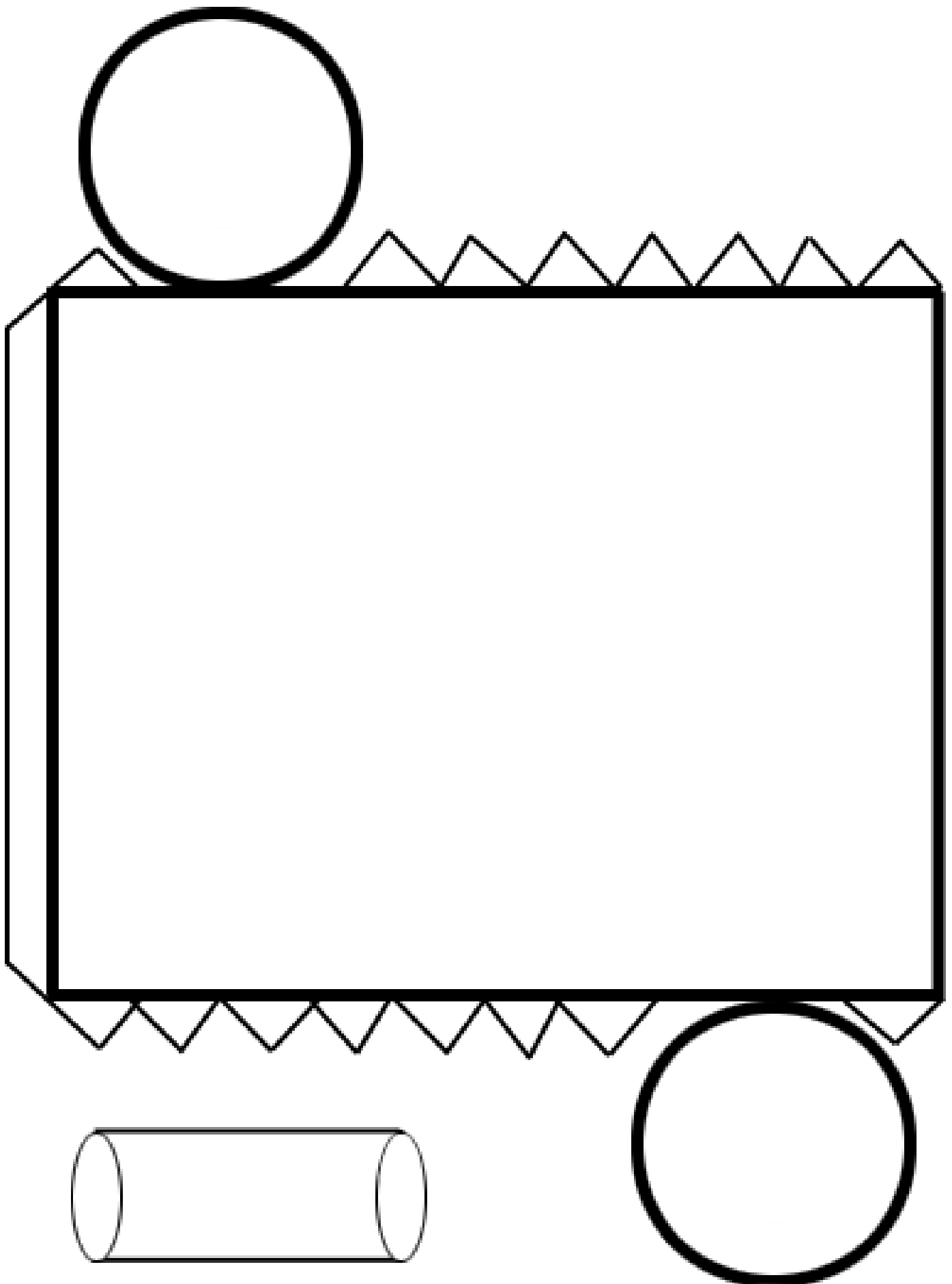

CONO

